



## Data sheet Grease Flow Transmitter 3/8" HV

## Datablad Fettflödesgivare 3/8" HV



**Art. Nr. 103105**



**General:** The meter is of oval gear type, with built in magnets in one of the oval gear wheels, together with a reed switch which closes twice every revolution. The meter is suitable for continuous measuring of oil, in for example circulating systems, which results in high measured volumes over time. (High Volume)

**Dimensions:** excl. connector (LxWxH): 59 x 50 x 38  
**Connection:** ISO-G 3/8"  
**Material:** Stainless steel AISI 316

**Weight:** 0.545 kg  
**Flow range:** 0 – 2,500 cm<sup>3</sup>/min  
**Temperature:** -20 °C - +70 °C  
**Vibrations:** 20 G (10 – 20,000 Hz)  
**Life:** 10<sup>9</sup> pulses, equal to approx. 655 m<sup>3</sup> (reed switch)

**Accuracy:** Grease NLGI 2: 0.655 cm<sup>3</sup>/pulse ± 3%  
 Oil ISO VG 150: 0.610 cm<sup>3</sup>/pulse ± 3%

**Electrical data:**  
**IP class:** IP 67  
**Connector:** 4-pol std. M12x1 male.  
 Pin 1: +  
 Pin 3: -  
 Pin 4: pulse

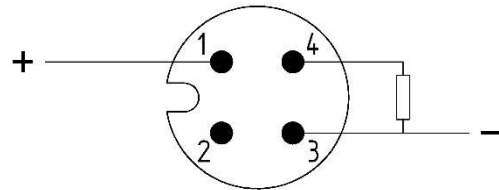

**Voltage:** 5 – 34 VDC  
**Power:** Current limitation

**Accessories:**  
 Art. No. 907133

Elbow contact M12x1, female with built in LED.  
 5 m PUR cable.

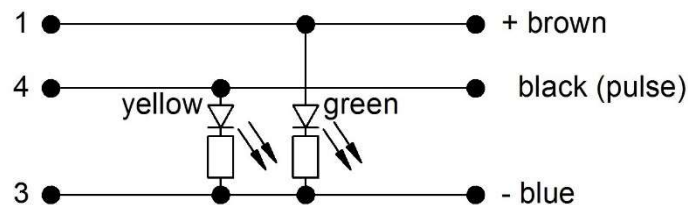

Art. No. 907134

Elbow contact M12x1, female.  
 5 m. PUR cable.

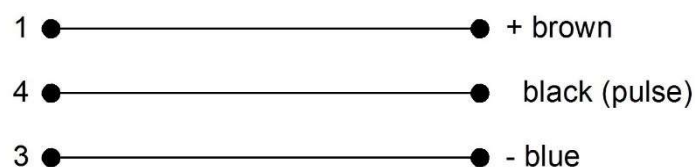



**Allmänt:** Mätaren är av ovalkugghjulstyp med inbyggda magneter i ett av ovalkugghjulen, samt ett tungelement som sluts två gånger per roterat varv. Mätaren lämpar sig för kontinuerlig mätning av olja, i t.ex. cirkulationssmörjsystem vilket ger upphov till höga uppmätta volymer över tid. (High Volume)

**Dimensioner:** exkl. kontakt (LxBxH): 59 x 50 x 38  
**Anslutning:** ISO-G 3/8"  
**Material:** Syrafast stål SS 2348

**Vikt:** 0,545 kg  
**Flödesområde:** 0 – 2 500 cm<sup>3</sup>/min  
**Temperatur:** -20 °C - +70 °C  
**Vibrationer:** 20 G (10 - 20 000 Hz)  
**Livslängd:** 10<sup>9</sup> pulser motsv. ca 655 m<sup>3</sup> (tungelement)

**Noggrannhet:** Fett NLGI 2: 0,655 cm<sup>3</sup>/puls ± 3%  
 Olja ISO VG 150: 0,610 cm<sup>3</sup>/puls ± 3%

**Eldata:**  
**Kapslingsklass:** IP 67  
**Anslutning:** 4-polig std. M12x1 hane.

Stift 1: +  
 Stift 3: -  
 Stift 4: puls

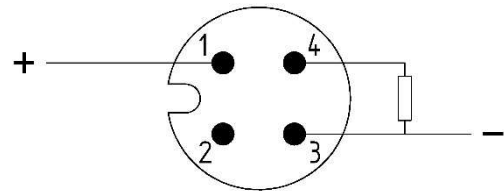

**Spänning:** 5 – 34 VDC  
**Ström:** Inbyggd begränsning

**Tillbehör:**  
 Art. nr. 907133

Vinklad kontakt M12x1, hona med inbyggd lysdiod.  
 5 m. PUR kabel

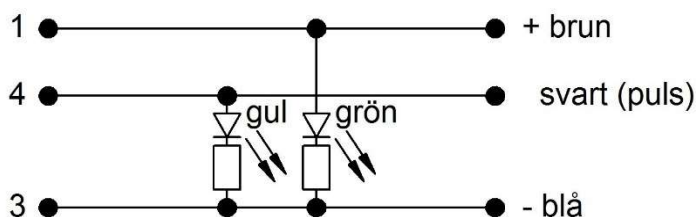

Art. nr. 907134

Vinklad kontakt M12x1, hona.  
 5 m. PUR kabel

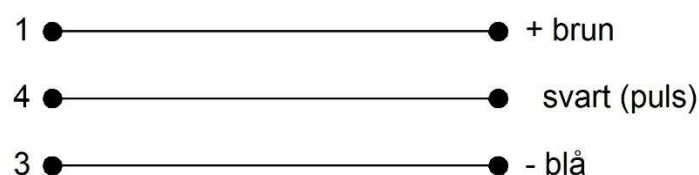

Dimensions  
Dimensioner

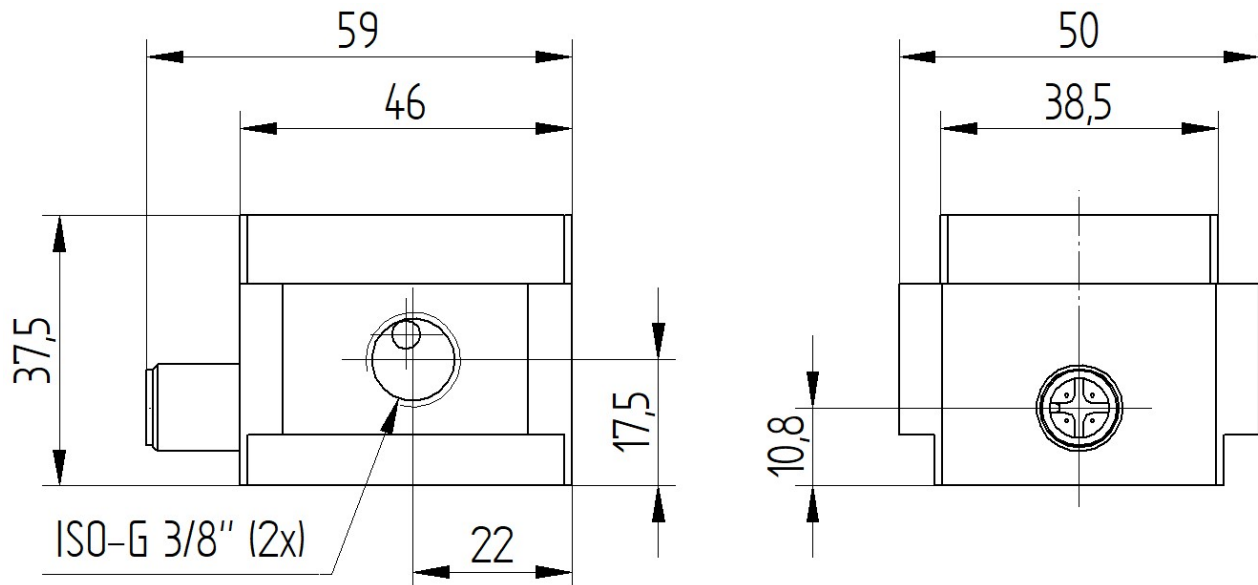

**ASSALUB AB**

[www.assalub.se](http://www.assalub.se)

Email: [info@assalub.se](mailto:info@assalub.se)

Tel: +46 120 358 40

P.O. Box 240, SE-597 26 Åtvidaberg, Sweden